

Macduff Robotics

Intelligent Subsea Equipment

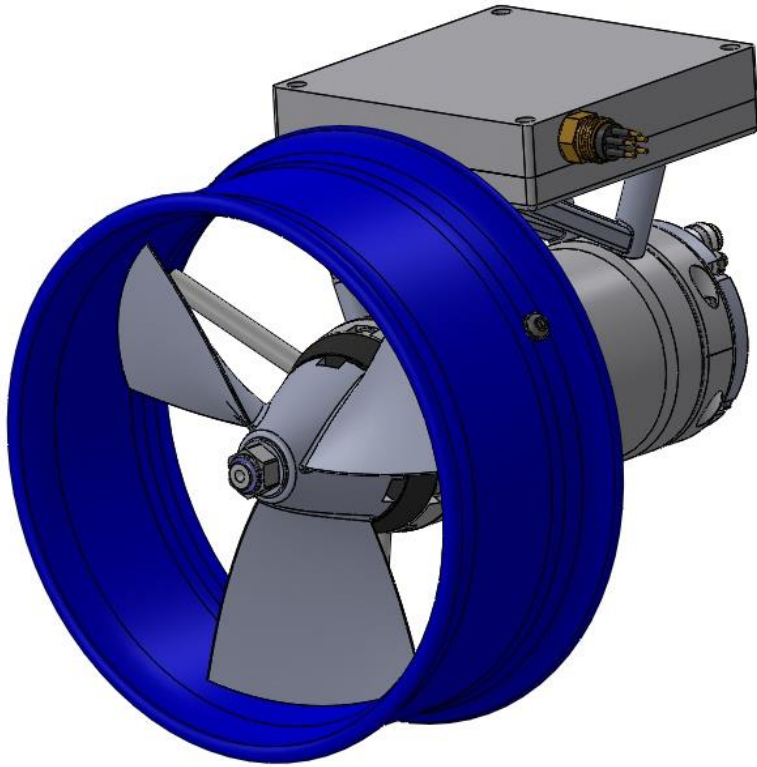

Description:

A powerful direct drive DC thruster.

Electric thruster unit 280mm nominal nozzle

MAIN FEATURES

- Direct drive
- Brushless direct current motor
- Aluminium propeller
- Drive electronics independently compensated from drive motor

Further Information

Spares kits also available

Equipment supplied

Standard tool supply includes

- Thruster unit
- Operating manual



info@macduff-robotics.com

Specifications

Weight in Air	TBC
Weight in sea water	TBC

Information contained in this data sheet is up-to-date and correct as at the date of issue. All product designs, specifications and data are subject to change without notice to improve reliability, function, design or otherwise. No express or implied warranties are given.